

Making a Hoop Pen for Pasture Poultry

Steve Skelton, Kentucky State University, Jacque Jacob and Tony Pescatore, University of Kentucky

Interest in pasture poultry production has been on the rise. This kind of poultry production typically involves housing the birds in a bottomless pen that is placed on pasture and moved at regular intervals. The flock has access to the pasture (plants and any associated insects) while providing them some protection from predators.

A hoop pen has several advantages:

- **Low cost.** It is a relatively inexpensive option for housing poultry on pasture.
- **Easy to move.** The finished hoop pen is relatively lightweight.
- **Strong.** Despite its light weight, the frame is strong enough to handle daily moving.
- **Allows a person to stand up.** The pen is built with two cattle panels and has a ceiling of about six feet.
- **Provides ventilation options.** The adjustable side curtain allows for different levels of ventilation as required for the changing weather conditions.

Step 1. Base Frame

Consists of: A 2x4 frame (four pieces) and a pair of 1x2 cleats (two pieces). All six pieces are cut to a length of 101 inches. Save offcuts for later use.

- Attach the cleats to two of the base frame members.
- Screw the 2x4s together to form the base frame.

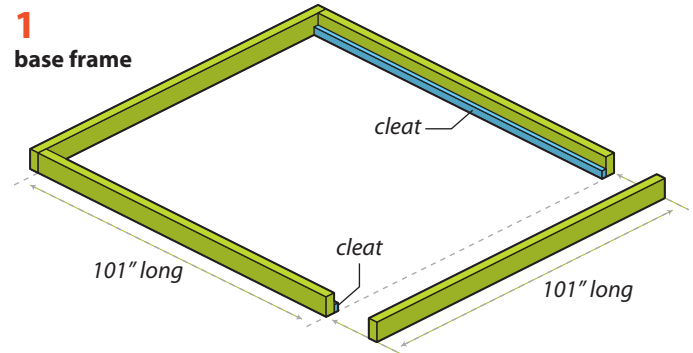

Note: See the back page for a list of materials needed to construct the hoop pen.



Drywall screws are used to attach the cleats.



A couple of deck screws per corner secure the base assembly 2x4s.

Step 2. Hoop

Consists of: Two cattle panels side-by-side, bent to form an arch.

- Attach panels to the inside of the base with fence staples.
- Connect the panels to each other with hog rings at every joint.



When bent, the 16-foot long cattle panels form a hoop approximately 6 feet in height.

2 hoop

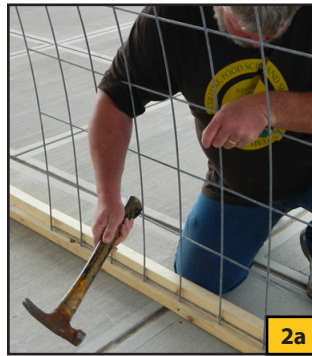
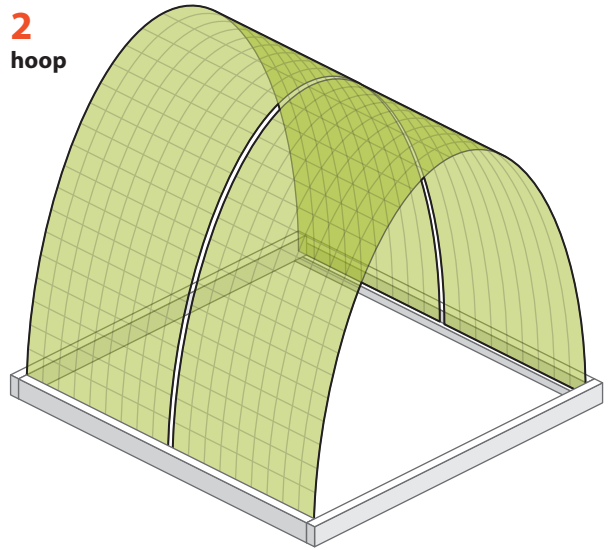

Cattle panels rest on the cleats and are secured with fence staples.

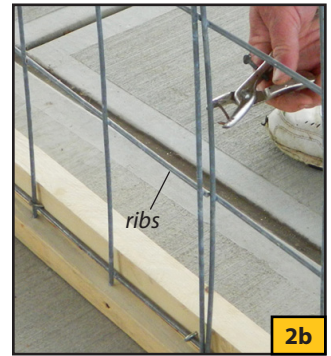

Hog rings tie the panels to each other. **Note:** Panel ribs should face the outside of the pen.

Step 3. Door Frame and Latch Plate

Consists of: Two 2x4s that serve as the hinge- and latch-side frame uprights, and a short length of 2x4 for a latch plate.

- Attach frames to the inside of the base with screws.
- Secure frames to the hoop with fence staples.
- Screw the latch plate to the latch-side frame.

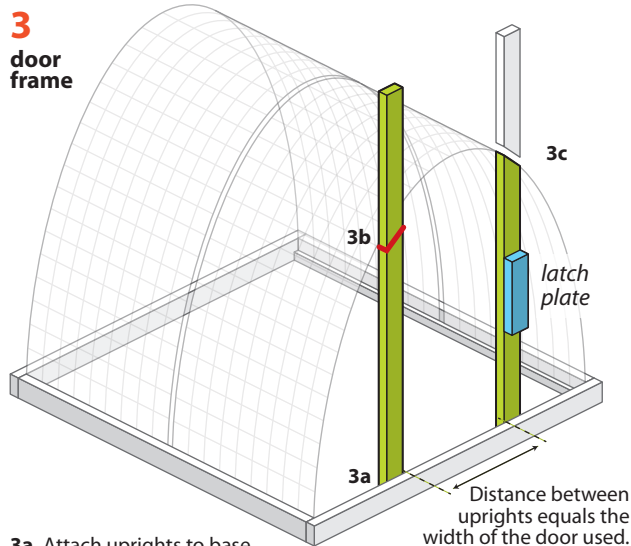

- Attach uprights to base.
- Mark hoop angle on uprights.
- Cut uprights, attach to hoop.



Three-inch deck screws secure the frame uprights to the base assembly.



Attach uprights to the hoop with fence staples.

Step 4. Door and Latch

Consists of: An old screen door and a gate latch.

- a. Face mount the door to the frame with a pair of hinges.
- b. Install gate latch.

Safety tip: Add a piece of string to the latch, and hang it inside the wire in case the door shuts and locks you in.

4 door

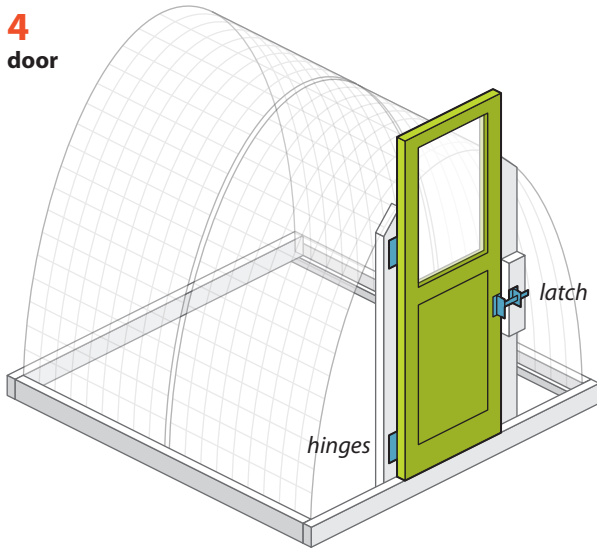

Step 5. Back Frame

Consists of: Lengths of 2x4s, which support and stiffen the back of the hoop.

- a. Cut the horizontal crossbar to length, and attach it to the hoop with fence staples.
- b. Cut the vertical uprights to length and attach.

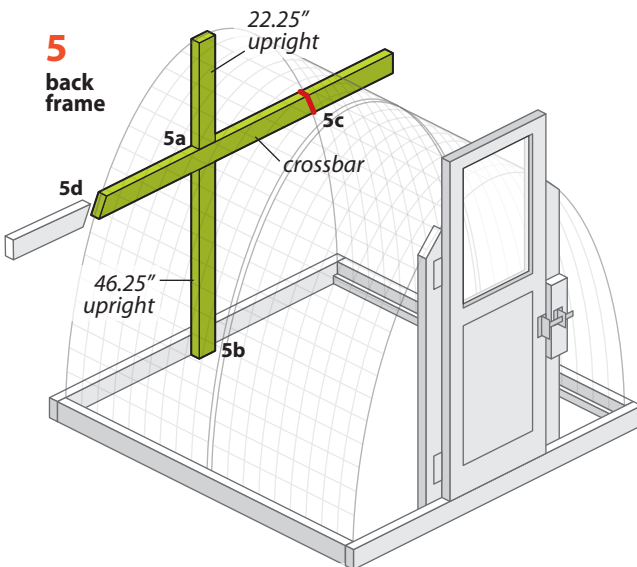

Cut the crossbar to length, and attach it to the hoop with fence staples.

Cut the uprights to length, and secure them to the base, the crossbar, and the hoop.

- 5a. Attach uprights to crossbar.
- 5b. Attach lower upright to base.
- 5c. Mark hoop angles on crossbar.
- 5d. Cut crossbar, attach frame to hoop.

Step 6. Corner Braces

Consists of: Lengths of 2x4s (four pieces), used to strengthen the base and as the point of attachment for the pull rope.

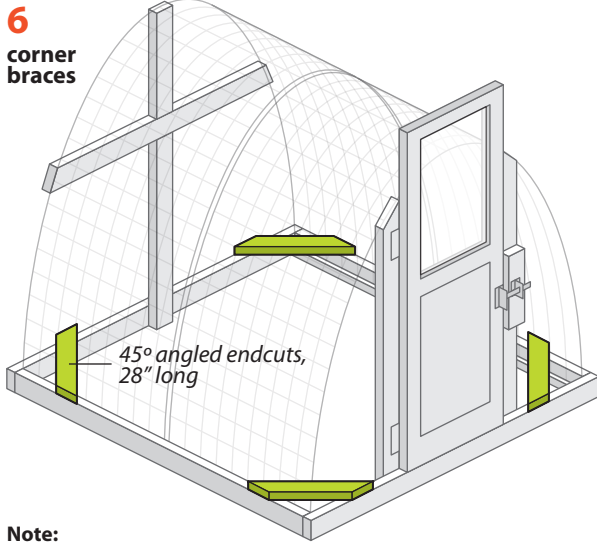

Note:
Dimensions in this figure are approximate.



Corner braces cut to a length of 28 inches should be just about the right length for attaching through the third opening in the cattle panel.

Step 7. Welded Wire

Consists of: Rolled welded wire, used to exclude predators.

- Apply wire to the outside of the hoop, rib side out.
- Attach to hoop with hog rings, wire, or plastic ties.
- Screw wire to the base using the fender washers, angling the screws down so the wire tightens as the screw is tightened.
- Attach to the back frame in the same manner.
- Overlap the ends and add additional wire as needed to fully cover any gaps.

Note: For areas with heavy predation, it might be necessary to cover the entire frame with welded wire.

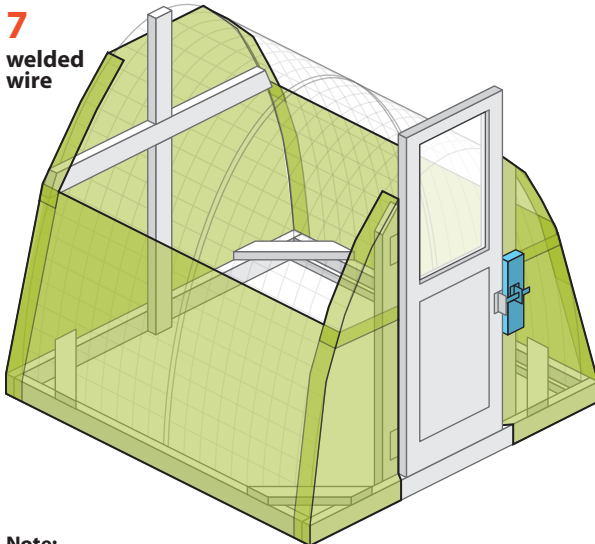

Note:
Remove latch plate before installing the welded wire, then reattach.

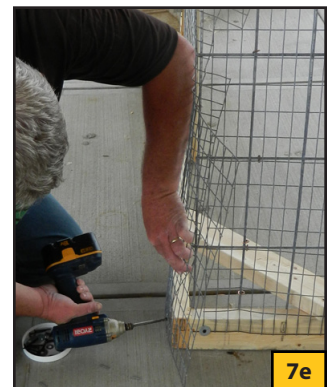

Step 8. Pull Rope

Tie the ends of a rope to the front two corner braces.

8
pull
rope

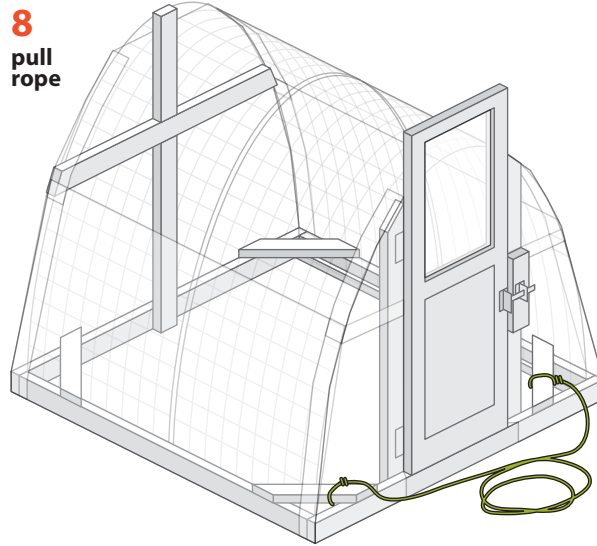

Step 9. Nest Boxes and Perches (optional)

It is best to add nest boxes and perches now, although they can be added later if needed.

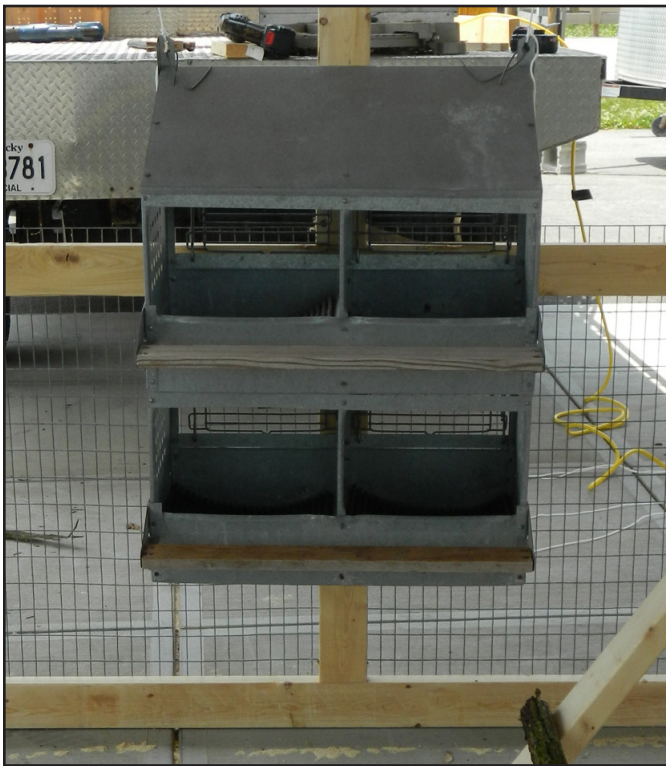

Nest boxes can be hung from the crossbar.



The perches are made from branches screwed to two 2x4s and attached to the cattle panels at the desired angle. In the up position, necessary for moving the pen from place to place (above), and in the down position (below).

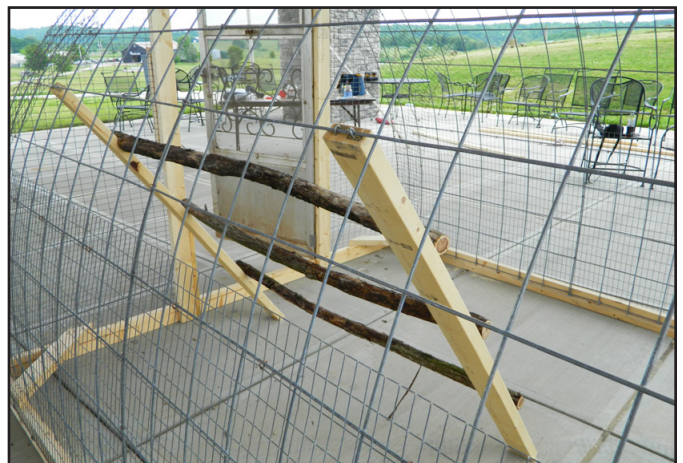

Step 10. Cover Hoop with Tarp

- Place the tarp over the cattle panel, and screw one side to the bottom frame using fender washers and drywall screws. Continue screwing the bottom of the tarp to the bottom frame at the back.
- Tie the front of the tarp to the cattle panels using straps.
- Tie one end of the nylon strap to the wire.
- Run the remaining length of nylon strap through the holes at the back of the tarp.
- Partially screw a drywall screw and washer on the bottom on the other side of the back brace.
- Loop the strap over this drywall screw and washer.
- Tie the ends of the strap together.

Modifications: You can use flexible plastic roofing to make the pen more permanent. However, this modification will limit ventilation possibilities.

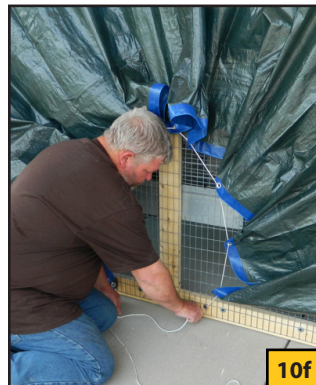

Feeders and waterers can be hung from the cattle panels. It is possible to suspend a bucket of water on the front panel. This bucket would supply water to an automatic bell drinker. Similarly, the bucket can be fitted with nipple drinkers and hung in the pen. Nipple drinkers reduce water spillage and can be kept cleaner.

Good Management Practices

Hoop pens work well in a pasture-poultry management system, but some important things should be kept in mind to use the hoop pens successfully.

Use the hoop pen on well-drained pastures. Poultry are tolerant of a wide range of environmental temperatures, including winter temperatures, as long as they are protected from the wind. Poultry cannot, however, tolerate cold temperatures when they are wet. To prevent the birds from getting wet, make sure the hoop pens are placed on well-drained pastures. Wet pastures also increase the likelihood of problems with internal parasites.

Place the hoop pen so wind and rain are not entering. You also need to orient your pens so the open end is not facing into bad weather. In cold weather it is important to provide the flock protection from the wind.

Age appropriate placement on pasture. The weather also will determine when you can place your birds on pasture. Young chicks are not able to maintain their own body temperature of 107°F. As a result they need supplemental heat for the first three weeks. That typically makes it harder to put young birds on pasture until after at least three weeks of age.

Do not overcrowd you birds. Hoop pens can be used for a variety of poultry. The number of birds they can hold varies with the size of the birds being raised. You can comfortably house about 50 broiler chickens to market age or 20 layers. With 20 hens, you will need at least four nest boxes—one box for every five hens. The number of turkeys you can house in a hoop pen will vary with the type of turkey. Because of their bigger size, you could only comfortably house about 10 turkeys in a single hoop pen.

Make sure the birds have fresh, clean water at all times. Make sure your birds have fresh, clean water every day. Birds can live longer without food than they can without water. You can have a reservoir of water on the outside of the pen feeding a bucket with nipple drinkers on the inside. If using nipple drinkers you need to provide one nipple for every 10 birds. If housing 20 layers you need at least two nipples, although three would be better. With layers, therefore, one bucket with two or three nipple drinkers is sufficient. If you have 50 broilers you will need five nipple drinkers, preferably two buckets of two to three nipples each. If using bell drinkers, you should follow the manufacturer's specifications.

Make sure the feed does not get wet. Wet feed can become moldy feed rather quickly. Molds can produce mycotoxins, which remain even if the moldy parts are removed. Mycotoxins adversely affect the health and performance of the flock. Hang the feeders away from the front opening of the tarp so that it is more protected from the rain.

Adjust the height of the feed and water as the birds get older. The height of the drinkers should be adjusted to accommodate the height of the birds. Nipple height should be adjusted as often as needed. As a general rule for broilers, the height must be adjusted at least every other day for the first two weeks of the flock and daily from that time on. The bottom of the triggering pin should be at eye level of day-old chicks. Nipples should be raised gradually so that birds must reach up and stretch slightly to activate the nipples from five days onward. Bell drinkers should be at the height of the back of the birds.

Similarly, the height of the feeder needs to be adjusted as the birds get older. If using a tube feeder you need one tube feeder for every 25 chickens. For a flock of 20 laying hens, you need one feeder. For a broiler flock of 50 chicks, you would need two. The height of the lip of the feeder should be at the height of the back of the chicken, making the feed accessible without having the birds waste feed.

Adjust the coverage of the tarp as required for the daily weather conditions. Ventilation needs to be increased during hot weather and reduced during the colder temperatures.

Move the hoop pen frequently. It is important the birds be placed on fresh pasture and the manure not be allowed to buildup. When the chicks are small, that movement can be every other day but quickly increases to every day and, for older broilers, perhaps twice a day. Laying hens should be moved daily.

Use proper pasture management. Whatever you choose as your pasture crop it needs to be managed properly. The chickens should not be placed on pasture when the forage is long and tough. If allowed to grow too long, the material is not effectively used by the flock and instead is just trampled down. Pasture should be allowed to recover before being used a second or third time in a single growing season. The recovery time will depend on the type of bird, the flock size, and how long they were left on a single piece of pasture.

Keeping these points in mind when using this type of hoop pen will help you raise a successful pasture poultry flock. For more information on poultry production, including pasture poultry, check out the www.eXtension.org Web site.

Equipment required:

- Hammer
- Electric screwdriver
- Electric handheld saw
- Wire cutters (side dykes)
- Pliers for hog rings
- Tape measure
- Pencil

Materials required:

	Size	Quantity	2012 Prices	Total
<i>Wood</i>				
2" x 4"	10' long	4	\$3.60	\$14.40
	8' long	4	\$2.40	\$9.60
1" x 2" furring strips	10' long	2	\$3.50	\$7.00
<i>Hardware</i>				
Hog rings	—	1 box	\$2.70	\$2.70
Deck screws	3"	1 lb.	\$8.70	\$8.70
Drywall screws	1½"	1 lb.	\$8.70	\$8.70
Fender washers	1"	1 lb.	\$4.50	\$4.50
Fence staples	1" x 1½"	1 lb.	\$3.75	\$3.75
Gate latch	—	1	\$4.00	\$4.00
Door strap hinges	—	2	\$2.70	\$5.40
<i>Other</i>				
1" x 2" 14-gauge welded wire	48" high	30'	\$1.25/ft.	\$37.50
Cattle panels	16' x 50"	2	\$20.00	\$40.00
Tarp	12' x 16'	1	\$23.50	\$23.50
Nylon rope	—	20'	\$0.80/ft.	\$16.00
Tie-down straps	—	—	\$3.85	\$3.85
Old door	—	—	\$8.00	\$8.00
Total				\$197.60 plus tax



Hog rings



3" deck screws



1½-inch drywall screws



Fence staples

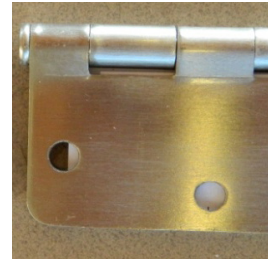

Hinges



Latch

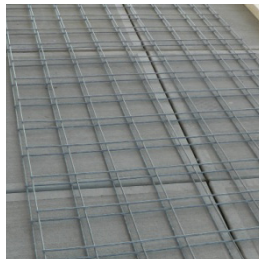

Cattle panel



Fender washers



1" x 2" 14-gauge welded wire



Nylon rope